

yuwell

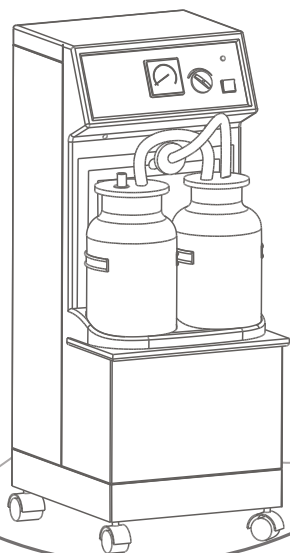

7A-23B/7A-23D Electric Suction Apparatus

User's Manual

Please read the user's manual closely before using!

SAFETY NOTES

WARNING:

The product is precision-made and carefully assembled and wired. Therefore, do not disassemble or attempt to repair the product. All repairs should be done by qualified personnel at an authorized repair center.

IMPORTANT SAFEGUARDS

When using electrical products, especially with children present, basic safety precaution should always be followed including the following:

1. DANGER-To reduce the risk of electrocution:
 - 1). Always unplug this product immediately after using.
 - 2). Do not use while bathing.
 - 3). Do not reach for product which has fallen into water. Unplug immediately.
 - 4). Do not place or store product where it can drop into water or other liquid.
 - 5). Do not come in contact with the suction apparatus while wet.
 - 6). Do not disassemble. Refer servicing to qualified service personnel.
 - 7). Periodic electric safety checks.
2. WARNING-To reduce the risk of burn, electrocution, fire or injury to persons.

SAFETY NOTES

1. A product should NEVER be left unattended when plugged in.
2. Closing supervision is necessary when this product is used near children or physically-challenged individuals.
3. Use this product for only intended use as described in this manual. Do not use attachments not recommended by the manufacturer.
4. Never operate this product if it has a damaged cord or plug, if it is not working properly, if it has been dropped or damaged, or dropped into water. Return the product to a service center for examination and repair.
5. Keep the cord away from HEAT or HOT surfaces.
6. NEVER block the air openings of the product. Keep the air openings free from lint, hair and the like
7. NEVER use while sleeping or drowsy.
8. NEVER drop or insert any object into any openings.
9. Do not use outdoors or operate where aerosol (spray) products are being used or where oxygen is being administered.
10. Electric and magnetic environment guidance in use.

FEATURES

PRODUCT APPLICATION

- ▶ Type 7A Electric Suction Apparatus is a mobile suction apparatus developed from similar products and equipped with new generation oil-free negative pressure pump. Electric suction apparatus is applicable for suction of purulence and viscosity fluid. It is not applicable for other use and using by non-medical staff.

CHARACTERS

- ▶ Piston driven vacuum pump assures steam free and lubrication free, which prevents bacterial contamination.
- ▶ Hand-switch and foot-switch for operating easily.
- ▶ Vacuum adjustment system can be adjusted if required.
- ▶ Working rationale (Figure 1).

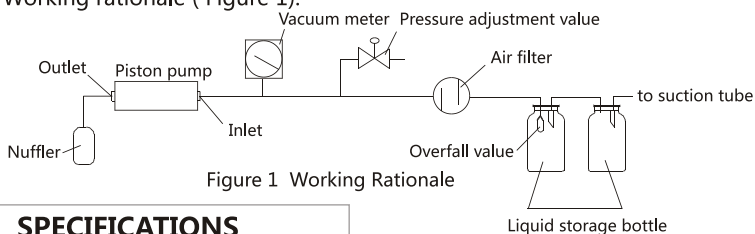

SPECIFICATIONS

1. High vacuum, high flow
2. Input power: 180VA
3. Power supply: AC120V±10% AC220V±10% AC230V±10%
 60Hz 50Hz
4. Max vacuum: ≥ 80 kPa
5. Adjustable vacuum range: 20 kPa ~ Max vacuum
6. Max airflow: ≥ 20 L/min(760mmHg)
7. Sound Level: ≤ 60 dB(A)
8. Suction bottle (glass): 2500ml/bottle, 2 bottles in a group
9. N.W.: 19.5kg(7A-23B), 15.5kg(7A-23D)
10. Dimension: 350×305×795(mm)(7A-23B), 360×320×480(mm)(7A-23D)

- ⊗ Do not use in inflammable or explosive place.
- ▶ Working system: Continuous operation with intermittent loading, maximum continuous working time is 30 minutes, continuity rate: 50%.
- ▶ Electric classification: Class I device, Type B application part.

WORKING CONDITION

Temperature range: +5°C ~ +35°C

Relative humidity: 30% ~ 80%

Atmosphere pressure: 86kPa ~ 106kPa

⚠ **NOTE** : When storage temperature is below 5°C, please keep the equipment in normal working condition for at least 4 hours before using.

ASSEMBLY AND DEBUGGING

CONNECTING LINE (Figure 2)

ⓘ **NOTE**: The blue point face on the air filter is air entrance, which should connect with exit of liquid storage bottle.

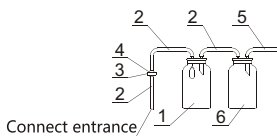

1. Buffer bottle 2. Soft tube 3. Air filter

4. "IN" mark 5. Soft tube 6. Store-liquid bottle

Figure 2 Connect Tubing

CONNECT POWER

Draw back handle, and take out power cord, then connect power.

⚠ **Caution**: This product should be grounded. In the event of electrical short circuit, grounding reduces the risk of electrical shock by providing an escape wire for the electric circuit. This product is equipped with a cord having a grounded wire with a grounding plug. The plug must be plugged into an outlet that is properly ground. Improper use of the grounding plug can result in a risk of electric shock.

CHECK TUBING

- ▶ Screw pressure regulator knob clockwise, and block up air entrance with fingers or rubbers, or pinch soft tube.
- ▶ Starting the unit, without abnormal noise, the needle on the vacuum meter rise to maximum pressure immediately. Unloosening air entrance, the needle will be below 20 kPa. That is to say that tube connections are right.

ADJUST VACUUM PRESSURE

Block up air entrance, switch on suction apparatus, and adjust pressure regulator. The readings of vacuum meter will change from 20 kPa to maximum pressure.

- ▶ Use pressure regulator to control required vacuum in clinic use.
- ▶ Vacuum Pressure will increase when clockwise turning round vacuum regulator valve.
- ▶ Turn down pressure below 20 kPa before switching off the machine.

EXAMINE, TEST OVERFALL DEVICE

- ▶ Open bottle plug, clean valve mouth, and make rubber valve slice flat on the buoy. There should no defects such as warp, crack of valve slice. Also the valve slice should connect well with buoy. The buoy shall move freely on the buoy frame.
- ▶ Carry the bottle plug by hand, to make a vertical contact with water. Then press down the bottle plug and the buoy float.
- ▶ Close the bottle plug, connect soft tube, then screw pressure regulator and switch on suction apparatus.
- ▶ Put soft tube into a pure water barrel, and inhale liquid to liquid storage bottle with overfall device. The buoy will float after liquid level rise, till valve mouth turnoff the, and suction shutdown.
- ▶ The liquid level with change with different suction method. Open bottle plug, and dump liquid storage bottle. When retightening bottle plug, buoy is at the bottom of the buoy frame, and valve mouth is open.
- ▶ In conformity with the above mentioned situation, the overfall device is in normal condition, and can be used in clinic.









CAUTION:

- ① If switching off the overfall device, the liquid level still rises, there are two reasons:
 - 1) One reason is the remained vacuum in the liquid storage bottle.
 - 2) Another reason is the valve mouth is not completely closed up.
- ① Go through the reason of the valve mouth's invalidation. When valve is shut off by buoy, the buoy could still be absorbed on the valve mouth. The reason is vacuum in the tube road. At this time, loosen pressure regulator or switch off suction apparatus to relieve vacuum in the tube road. Under the effect of gravity, buoy will fall from valve mouth. (Strictly prohibit pulling buoy with hand to avoid valve slice come over with buoy.)
- ① After stopping the machine, relise negative pressure, then open the bottle plug.
- ⊖ Do not use the suction apparatus when removing overfall device and draught tubes.

TURN OFF MACHINE

Switch off the suction apparatus first, then pull out power cord from power socket, and cut off net power supply.

SYMBOL AND SIGNIFICATION

Symbol	Signification	Symbol	Signification
	Alternating current		Consult the manual
	Earthing		Type B application part
	OFF(power, disconnection from the mains)		ON(power, connection to the mains)
	KEEP UP		FRAGILE
	KEEP DRY		

OPERATING AND MAINTENANCE

The equipment must be used by the medical professionals, strictly according to the manual's and operational steps.

OPERATING

- ▶ Before using apparatus, check under the process of assembling and debugging. Then connect disinfected soft tube and abdomen suction tube to liquid storage bottle.
- ▶ When using, adjust vacuum with pressure regulator, and pay attention to the liquid level in the liquid storage bottle.
- ▶ When inhaled liquid is not too much at one time, do not to allow liquid to enter the second liquid storage bottle. When the first liquid storage bottle rises to prescribed volume (The machine tilted through an angle of 10°C is applicable still), you must stop inhaling. After dump and clean the liquid storage bottle, reuse it. Then the second liquid storage bottle is regarded as buffer bottle to avoid liquid entering pump body.
- ▶ When inhaled liquid is too much at one time, liquid will enter the second liquid

storage bottle. Dump the liquid storage bottle in time, or more liquid will rise with buoy, closing up to valve mouth and to auto-stop suction.

- ▶ After shutting off overfall device, liquid level still rise, please read "EXAMINE, TRY OVERFALL DEVICE".

REPLACE AIR FILTER

If dirt or froth in air filter, the color of filter velum will turn from light to deep, and the attractive force will decrease or even disappear, while vacuum will rise to more than 40 kPa. At this time, air filter should be replaced in time with the origin one from the manufacturer.

Air filter should be replaced frequently, and destroyed together.

REPLACE FUSE TUBE

Fuse tube is fixed at the back of the pedestal. CUT OFF power supply first Before changing. Unscrew fuse box counterclockwise, then change the fuse tube. (Type: F2AL250V, $\Phi 5 \times 20$)

MAINTENANCE

1.CLEANING CABINET

- ▶ WARNING: CUT OFF the power supply first. To avoid electrical shock, DO NOT remove cabinet.
- ▶ Clean the cabinet with a mild household cleaner and non-abrasive cloth or sponge at least one time each month.

2.CLEANING TUBING

- ▶ Before stopping the machine, it's better to inhale little pure water to suction tube to clean tubing each time.

3.CLEANING COLLECTION CONTAINER

(Include overfall device, and valve slice should connect well with buoy.)

- ▶ Clean collection container after using each time.
- ▶ After stopping the machine, dump liquid storage bottle. Clean bottle surface and cover with soft brush, non-abrasive dishcloth or sponge. Rinse them with pure water thoroughly.

4. DISINFECTION

- ▶ Disinfect collection container and soft tubing according to this method: soak in a

chlorine-antiseptic. Consistency of 1000mg/L~2000mg/L disinfectant solution for one hour. Disinfect metalline suction tube with 134℃±3℃ saturated steam for 20 minutes. Clean the cabinet with a moist rag soaked with disinfectant, and prevent liquid seeping into the cabinet.

⚠️ **Note:** Please check appearance condition of the power cable insulation skin, elasticity of the plug and receptacle, on-off condition of the power switch, fastening condition of the electric components before the next use. Make sure the periodic electric safety. If any questions, please contact the supplier or manufacturer.

TROUBLE SHOOTING GUIDE

Problem	Probable reasons	Solution	Remark
The maximum vacuum is below 80 kPa	<ol style="list-style-type: none"> 1. Gas leakage at bottle-mouth 2. Gas leakage at tube 3. Pressure regulator is loose 4. Surrounding atmosphere is not as required 	<ol style="list-style-type: none"> 1. Clean mouth of bottle, tighten or replace bottle cover 2. Tighten joints 3. Screw pressure regulator 4. Move the machine to required atmosphere 	Repairing by qualified personnel
Vacuum is beyond 40 kPa, but suction power of tubeoutlet reduce obviously or disappear	<ol style="list-style-type: none"> 1. Overfall device is shut off 2. Tubing jammed 3. Air filter jammed 	<ol style="list-style-type: none"> 1. After stopping the machine, relieve pressure and rescrew firmly 2. Dredge, clean orreplace soft tubes 3. Replace air filter 	Dump empty liquid storage bottle in time
Power voltage is normal, but indicator lamp is not bright	<ol style="list-style-type: none"> 1. The power socket is loose 2. Fuse tube is broken 3. Indicator lamp is damaged 	<ol style="list-style-type: none"> 1. Repair or exchange the power socket 2. Change fuse tube 3. Change indicator lamp 	Repairs by qualified personnel
Fuse tube is broken	<ol style="list-style-type: none"> 1. Overhigh voltage 2. Circuit breakdown 3. Relay breakdown 4. Pump body is jammed 	<ol style="list-style-type: none"> 1. Regulate voltage 2. Examine circuit, and exclude breakdown 3. Adjust or exchange relay 4. Examine pump body and motor 	

For other problems, TURN OFF the concentrator first, and contact dealer or manufacturer immediately.

OTHER ATTENTION ITEMS

LIMITATION OF TRANSPORT AND STOCK

Temperature range: $-40^{\circ}\text{C} \sim +55^{\circ}\text{C}$

Relative humidity: 10% ~ 93%

Atmosphere pressure range: 70kPa~106kPa

Note: The product must be stored in a eration with out erode gas, avoided shocking and inversion in transport.

Electric Rationale

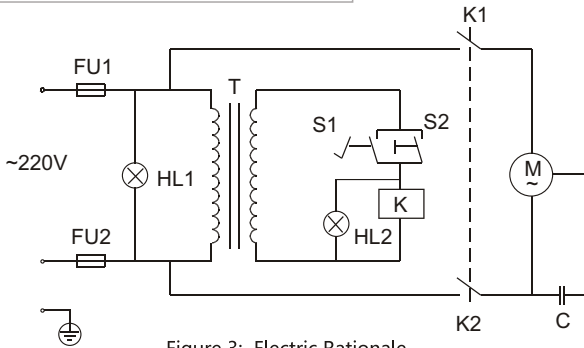

Figure 3: Electric Rationale

ACCESSORIES LIST

Abdomen suction tube	1PC	Suction soft tube $< \Phi 7 \times \Phi 12$, length 2m	1PC
Fuse tube $< \text{F2AL250V}, \Phi 5 \times 20 >$	2PCS	Air filter	2PCS
Power cord	1PC	Foot-switch	1PC
Manual	1PC		

TO DISPOSE THE CASTOFF

The castoff should be disposed in accordance with all applicable government regulations.

All specifications and product configurations are subject to change without notification.

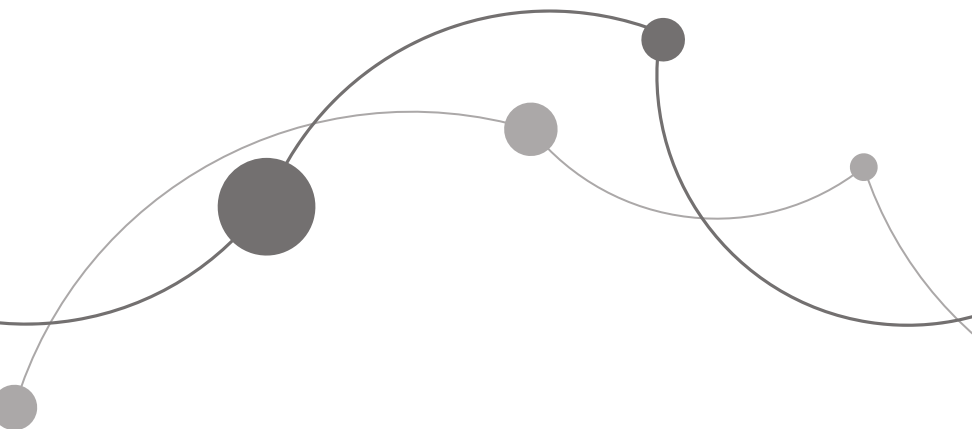

JIANGSU YUYUE MEDICAL EQUIPMENT & SUPPLY CO.,LTD.
Sales Center Address: Huanyuan East Road No.1,Xuzhuang
Software Park, Nanjing, Jiangsu Province, P.R. China, 210000
Manufacturing Address: YunYang Industrial Park
DanYang, Jiangsu Province, P.R. China, 212300
<http://www.yuwell.com>