

RESMED

VPAP™ Auto

VPAP™ ST

VPAP™ S

POSITIVE AIRWAY PRESSURE DEVICE

H5i™

HEATED HUMIDIFIER



Welcome Guide

English

S9™ Series
More. Comfort.

S9[™] | Series
More. Comfort.

Welcome

Thank you for choosing the S9 VPAP Series or H5i. Before operating these devices, please read the entire Welcome and Information Guides.

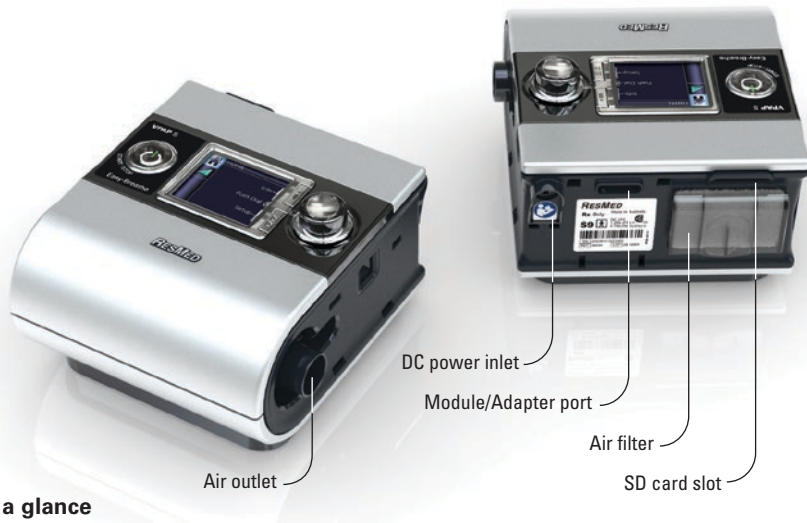

S9 at a glance

The S9 system comprises the following elements:

- S9 device
- Air tubing
- 90W power supply unit
- S9 Travel bag
- SD card
- S9 SD card protective folder.

Optional components include:

- H5i heated humidifier
- Standard air tubing
- SlimLine air tubing
- 3m air tubing
- ClimateLine heated air tubing
- ClimateLine^{MAX} heated air tubing
- 30W power supply unit (does not support H5i)
- Power Station II battery pack
- DC/DC Converter 24V/90W.

Traveling with the S9

When traveling with your S9 only:

- Ensure you pack the SlimLine or Standard air tubing as the ClimateLine or ClimateLine^{MAX} heated air tubing is not designed to connect directly to the device.
- Please ensure you purchase and travel with the approved power cord for the region where you will be using the device.

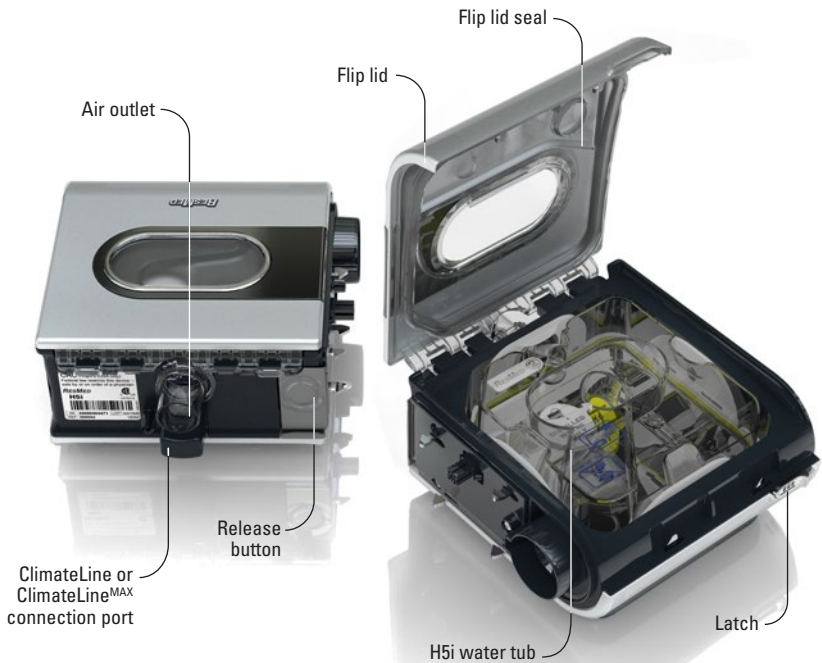

H5i at a glance

The H5i system comprises the following elements:

- H5i heated humidifier
- H5i standard water tub
- ClimateLine^{MAX} heated air tubing (if sold as a Climate Control Kit).

Optional components include:

- ClimateLine heated air tubing
- H5i cleanable water tub.

Traveling tips

When moving or traveling with your H5i:

- Ensure that the water tub is empty.
- Disconnect the H5i from the S9 by using the release button.



Setup

1. Align your H5i with your S9 and push them together until they click into place.
2. Connect the DC plug of the power supply unit to the rear of the S9.
3. Connect the power cord to the power supply unit.
4. Plug the other end of the power cord into the power outlet.
5. Connect one end of the air tubing firmly onto the air outlet.
6. Connect the assembled mask system to the free end of the air tubing.

Notes:

- Always ensure that the S9 and H5i are placed on a stable, level surface for proper operation.
- Place the power supply unit away from the H5i to allow for adequate ventilation.
- For more information on assembling your mask see your mask user guide.
- Recommended masks are available on www.resmed.com on the Products page under Service & Support.

Filling the water tub

1. Slide the latch and lift open the flip lid.
2. Remove the water tub.
3. Fill the water tub (through the center hole) with distilled or deionized water up to the maximum water level mark (380 mL).
4. Return the water tub to the H5i.
5. Close the flip lid ensuring that it clicks into place.



S9 basics

Start/Stop button
Starts or stops treatment.

LCD screen
Displays the menus, treatment screens and reminders.

Info menu*
Allows you to view your sleep statistics or exit from the menu.

Setup menu*
Allows you to make changes to settings or exit from the menu.

Push dial
Turning the dial allows you to scroll through the menu and change settings. Pushing the dial allows you to enter into a menu and confirm your choice.

Key:

Home 

Humidity level 

Ramp 

Heated tube 

Climate Control 

Start/ Stop 

Push dial 

Setup menu 

Info menu 

*The Info and Setup menus are disabled if S9 Essentials has been enabled by your clinician.

Adjusting humidity level

Ranging from OFF to 6, you can adjust the humidity level at any time to find the setting that is most comfortable for you. To adjust your level of humidity:



1. From your HOME screen, turn the dial until the HUMIDITY LEVEL screen is displayed in blue.



2. Press the dial. The selection is highlighted in orange.



3. Turn the dial until the humidity level that you require is displayed.



4. Press the dial to confirm your choice.

Warming the H5i

The warm-up feature is used to pre-heat the water before starting treatment.

To start warming:

1. Navigate to the humidity level icon.
2. Push and hold the dial for three seconds. The Warming Up status bar is displayed.

You can stop warm-up at any time by pressing the dial for at least three seconds. You can start treatment at any time by pressing the power button.

Note: In order to assist the heater plate in cooling, your S9 device will continue to blow air for up to an hour after treatment has stopped. However, you can unplug the device from the power outlet at any time and allow the heater plate to cool without air flow.



Adjusting ramp time

Designed to make the beginning of treatment more comfortable, ramp time is the period during which the pressure increases from a low start pressure to the treatment pressure. To adjust your ramp time:



1. From your HOME screen, turn  until the RAMP screen is displayed in blue.



2. Press . The selection is highlighted in orange.



3. Turn  until the ramp time you require is displayed.



4. Press  to confirm your choice.

Using mask-fit

You can use mask-fit to help you fit your mask properly. This feature delivers treatment pressure for a three-minute period, prior to starting treatment, during which you can check and adjust your mask-fit to minimize leaks.

1. Fit your mask as described in the mask user guide.
2. From your HOME screen, push and hold  for three seconds.

One of the following MASK FIT screens is displayed:



3. If necessary, adjust your mask, mask cushion and headgear until you have a Good mask-fit. After three minutes, the pressure reverts to the set pressure and treatment will begin. You can end mask-fit at any time by pressing .

S9 Essentials

S9 Essentials is designed to make device interaction and menu navigation easier for you. If enabled by the clinician, S9 Essentials disables the Info and Setup functionality so that you can simply start and stop therapy and adjust ramp, humidification and Climate Control.

Selecting the mask type

To select your type of mask:



1. Press . The SETTINGS screen is displayed.



2. Turn  until Mask is displayed in blue.



3. Press . The selection is highlighted in orange.



4. Turn  until the mask setting that you require is displayed.



5. Press  to confirm your choice.

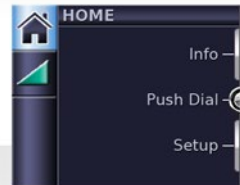



6. Push  to return to the HOME screen.

Note: Selecting the mask type is not possible if S9 Essentials has been enabled by your clinician.



Getting started

1. Make sure the power is connected.
2. Adjust the ramp time or humidification level if required.
3. Fit your mask as described in your mask user guide.
4. To start therapy, simply breathe into the mask and/or press .
5. Lie down and arrange the air tubing so that it is free to move if you turn in your sleep.
6. To stop treatment at any time, remove your mask and/or press .

Notes:

- If your clinician has enabled SmartStart your device will start automatically when you breathe into the mask and stop automatically when you remove your mask.
- If power is interrupted during treatment, the device automatically restarts therapy when power is restored.

Viewing the treatment screens

Depending on how the system has been configured, you will see one of the following example screens once therapy has started:



- ✓ H5i humidifier



- ✓ H5i humidifier
- ✓ ClimateLine or ClimateLine^{MAX} heated air tube
- ✓ Climate Control – Auto



- ✓ H5i humidifier
- ✓ ClimateLine or ClimateLine^{MAX} heated air tube
- ✓ Climate Control – Manual



- ✓ Standard S9 without optional accessories



- ✓ Oximetry data via the oximeter adapter

In S, ST and VAuto modes, the fixed lines on the pressure bar indicate the expiratory and inspiratory pressures. In CPAP mode, only a set pressure is shown. While the treatment is ramping (indicated by an orange ramp icon below the pressure bar), the pressure values appear in orange. When a set pressure is reached these values are displayed in white.

To toggle between treatment screens 1 and 2, press  from your HOME screen.



- ✓ **(ST mode)** Treatment with device trigger (Timed) and cycle (Timed, Ti Max or Ti Min) breath indicators
- ✓ **(ST mode)** Treatment with spontaneous trigger and cycled breaths

Viewing the Info menu

The Info menu has a series of screens showing your sleep quality, sleep report and service information.

To view the Info menu, push  from your HOME screen.

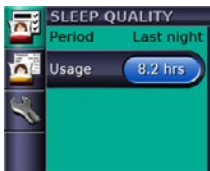

- ✓ In the Sleep Quality screen, you can always view your usage hours during the last session and if enabled by your clinician, data on mask-fit and AHI is displayed.
- ✓ In the Sleep Report, only the period can be changed—other values are for display only.
- ✓ In the Service information, the total device run hours (includes warm-up/cool-down times for the humidifier) and the software identifications are displayed.

To return to the HOME screen, push .

Cleaning and maintenance

You should regularly carry out cleaning and maintenance as described in this section.

Disassembling the H5i water tub

1. Slide the latch.
2. Lift open the flip lid.
3. Remove the water tub.
4. Discard any excess water from the water tub.
5. Unclip all four side latches.
6. Pull apart the tub lid and base.

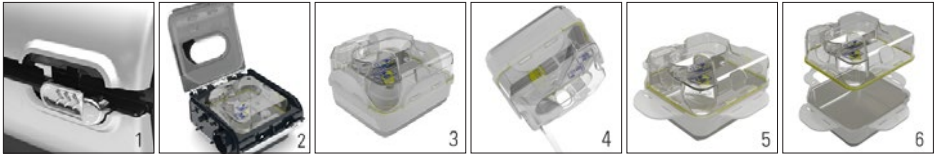

Daily cleaning

1. Remove the air tubing by pulling off the finger grips on the cuff. Hang it in a clean, dry place until next use.
2. Wash the disassembled tub lid and base in warm water using a mild detergent.
3. Rinse thoroughly in clean water and allow them to dry away from direct sunlight.

Notes:

- Do not hang the air tubing in direct sunlight as it may harden over time and eventually crack.
- Do not wash the air tubing in a washing machine or dishwasher.

Weekly

1. Remove the air tubing from the S9 device and the mask.
2. Wash the air tubing in warm water using mild detergent.
3. Rinse thoroughly, hang, and allow to dry.
4. Before next use, reconnect the air tubing to the air outlet and mask.

Monthly

1. Wipe the exterior of the S9 and H5i with a damp cloth and mild detergent.
2. Check the air filter for holes and blockage by dirt or dust.
3. Peel the flip lid seal from the flip lid and wash it in warm water using a mild detergent.

Maintenance checklist

- ✓ Inspect the H5i water tub and flip lid seal for wear and deterioration.
- ✓ Replace the water tub if any component is leaking or has become cracked, cloudy or pitted.
- ✓ Replace the flip lid seal if cracked or torn.
- ✓ Clean white powder deposits in the water tub by using a solution of one part household vinegar to 10 parts water.

Reassembling and filling the H5i water tub

1. Place the tub lid back onto the base.
2. Clip all four side latches.
3. Fill the water tub with distilled or deionized water up to the maximum water level mark.
4. Return the water tub to the H5i.
5. Close the flip lid ensuring that it clicks into place.

Replacing the air filter

Replace the air filter every six months (or more often if necessary).

1. Remove the air filter cover from the back of the S9 device.
2. Remove and discard the old air filter.
3. Insert a new ResMed air filter ensuring that it is sitting flat in the air filter cover.
4. Replace the air filter cover.

Notes:

- *Ensure the air filter and air filter cover are fitted at all times.*
- *Do not wash the air filter. The air filter is not washable or reusable.*

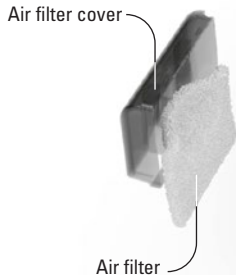

S9[™] | Series
More. Comfort.

368436/3 2017-11
S9 VPAP Series
H5i
WELCOME
AMER



Manufacturer: ResMed Pty Ltd 1 Elizabeth Macarthur Drive Bella Vista NSW 2153 Australia.

See www.resmed.com for other ResMed locations worldwide.

For patent information, see www.resmed.com/ip.

S9 VPAP Auto, H5i, ClimateLine, SlimLine and SmartStart are trademarks of ResMed Pty Ltd. S9, ClimateLine, SmartStart and VPAP are registered in U.S. Patent and Trademark Office.

© 2017 ResMed.